



## Xiaomi Portable Electric Air Compressor 1S Manual: Safety Precautions & Instructions

[Home](#) » [Xiaomi](#) » **Xiaomi Portable Electric Air Compressor 1S Manual: Safety Precautions & Instructions**

The Xiaomi Portable Electric Air Compressor 1S is a powerful and versatile tool that can be used for a variety of purposes, from inflating car tires to sports equipment and inflatable toys. However, as with any power tool, it is important to use the device safely and correctly to avoid accidents and injury. This user manual provides detailed instructions on how to use the air compressor, as well as important safety precautions that should be followed at all times. Users are advised to read the manual carefully before operating the air compressor and to retain it for future reference. The manual includes warnings related to electrical safety, personal safety, and work area safety, as well as instructions on how to properly maintain the device. Additionally, the manual provides information on how to store and dispose of the air compressor's built-in lithium battery safely. By following the instructions and precautions outlined in this manual, users can ensure that they get the most out of their Xiaomi Portable Electric Air Compressor 1S while staying safe and avoiding potential hazards.

## Contents [ [hide](#) ]

### 1 [Xiaomi Portable Electric Air Compressor 1S](#)

#### 1.1 [Work area safety](#)

### 2 [Precautions](#)

### 3 [Product Overview](#)

### 4 [Parts Description](#)

### 5 [Electric Air Compressor Safety Warnings](#)

### 6 [How to Use](#)

#### 6.1 [Battery Level Indicator & Charging Battery Level Indicator](#)

#### 6.2 [Charging](#)

#### 6.3 [Turning on / off](#)

#### 6.4 [Connecting the High-pressure Air Hose and Nozzle Schrader Valve](#)

#### 6.5 [Presta Valve Adapter](#)

#### 6.6 [Needle Valve Adapter](#)

#### 6.7 [Air Pressure Reference Table](#)

#### 6.8 [Pressure Presets](#)

#### 6.9 [Inflating](#)

#### 6.10 [Disconnecting the Air Hose](#)

### 7 [Care & Maintenance](#)

### 8 [Troubleshooting](#)

### 9 [Specifications](#)

### 10 [Noise Value and Vibration](#)

### 11 [Symbol Descriptions](#)

#### 11.1 [To Recycling Organizations](#)

### 12 [FAQS](#)

### 13 [Documents / Resources](#)

#### 13.1 [References](#)

### 14 [Related Posts](#)



## Xiaomi Portable Electric Air Compressor 1S



Read this manual carefully before use, and retain it for future reference. Original Instructions

## **WARNING**

### General power tool safety warnings

Read all safety warnings, instructions, illustrations and specifications provided with this power tool. Failure to follow all instructions listed below may result in electric shock, fire and/or serious injury.

Save all warnings and instructions for future reference. The term “power tool” in the warnings refers to your mains-operated (corded) power tool or battery-operated (cordless) power tool.

### **Work area safety**

- Keep work area clean and well lit. Cluttered or dark areas invite accidents.
- Do not operate power tools in explosive atmospheres, such as in the presence of flammable liquids, gases or dust. Power tools create sparks which may ignite the dust or fumes.
- Keep children and bystanders away while operating a power tool. Distractions can cause you to lose control.

### **Electrical safety**

- Power tool plugs must match the outlet. Never modify the plug in any way. Do not use any adapter plugs with earthed (grounded) power tools. Unmodified plugs and matching outlets will reduce risk of electric shock.
- Avoid body contact with earthed or grounded surfaces, such as pipes, radiators, ranges and refrigerators. There is an increased risk of electric shock if your body is earthed or grounded.
- Do not expose power tools to rain or wet conditions. Water entering a power tool will increase the risk of electric shock.
- Do not abuse the cord. Never use the cord for carrying, pulling or unplugging the power tool. Keep cord away from heat, oil, sharp edges or moving parts. Damaged or entangled cords increase the risk of electric shock.
- When operating a power tool outdoors, use an extension cord suitable for outdoor use. Use of a cord suitable

for outdoor use reduces the risk of electric shock.

- If operating a power tool in a damp location is unavoidable, use a residual current device (RCD) protected supply. Use of an RCD reduces the risk of electric shock.

## **Personal safety**

- Stay alert, watch what you are doing and use common sense when operating a power tool. Do not use a power tool while you are tired or under the influence of drugs, alcohol or medication. A moment of inattention while operating power tools may result in serious personal injury.
- Use personal protective equipment. Always wear eye protection. Protective equipment such as a dust mask, non-skid safety shoes, hard hat or hearing protection used for appropriate conditions will reduce personal injuries.
- Prevent unintentional starting. Ensure the switch is in the off-position before connecting to power source and/or battery pack, picking up or carrying the tool. Carrying power tools with your finger on the switch or energising power tools that have the switch on invites accidents.
- Remove any adjusting key or wrench before turning the power tool on. A wrench or a key left attached to a rotating part of the power tool may result in personal injury.
- Do not overreach. Keep proper footing and balance at all times. This enables better control of the power tool in unexpected situations.
- Dress properly. Do not wear loose clothing or jewellery. Keep your hair and clothing away from moving parts. Loose clothes, jewellery or long hair can be caught in moving parts.
- If devices are provided for the connection of dust extraction and collection facilities, ensure these are connected and properly used. Use of dust collection can reduce dust-related hazards.
- Do not let familiarity gained from frequent use of tools allow you to become complacent and ignore tool safety principles. A careless action can cause severe injury within a fraction of a second.

## **Power tool use and care**

- Do not force the power tool. Use the correct power tool for your application. The correct power tool will do the job better and safer at the rate for which it was designed.
- Do not use the power tool if the switch does not turn it on and off. Any power tool that cannot be controlled with the switch is dangerous and must be repaired.
- Disconnect the plug from the power source and/or remove the battery pack, if detachable, from the power tool before making any adjustments, changing accessories, or storing power tools. Such preventive safety measures reduce the risk of starting the power tool accidentally.
- Store idle power tools out of the reach of children and do not allow persons unfamiliar with the power tool or these instructions to operate the power tool. Power tools are dangerous in the hands of untrained users.
- Maintain power tools and accessories. Check for misalignment or binding of moving parts, breakage of parts and any other condition
- that may affect the power tool's operation. If damaged, have the power tool repaired before use. Many accidents are caused by poorly maintained power tools.
- Keep cutting tools sharp and clean. Properly maintained cutting tools with sharp cutting edges are less likely to bind and are easier to control.
- Use the power tool, accessories and tool bits etc. In accordance with these instructions, taking into account the

working conditions and the work to be performed. Use of the power tool for operations different from those intended could result in a hazardous situation.

- Keep handles and grasping surfaces dry, clean and free from oil and grease. Slippery handles and grasping surfaces do not allow for safe handling and control of the tool in unexpected situations.

### **Battery tool use and care**

- Recharge only with the charger specified by the manufacturer. A charger that is suitable for one type of battery pack may create a risk of fire when used with another battery pack.
- Use power tools only with specifically designated battery packs. Use of any other battery packs may create a risk of injury and fire.
- When battery pack is not in use, keep it away from other metal objects, like paper clips, coins, keys, nails, screws or other small metal objects, that can make a connection from one terminal to another. Shorting the battery terminals together may cause burns or a fire.
- Under abusive conditions, liquid may be ejected from the battery; avoid contact. If contact accidentally occurs, flush with water. If liquid contacts eyes, additionally seek medical help. Liquid ejected from the battery may cause irritation or burns.
- Do not use a battery pack or tool that is damaged or modified. Damaged or modified batteries may exhibit unpredictable behaviour resulting in fire, explosion or risk of injury.
- Do not expose a battery pack or tool to fire or excessive temperature. Exposure to fire or temperature above 130 °C may cause explosion.
- Follow all charging instructions and do not charge the battery pack or tool outside the temperature range specified in the instructions. Charging improperly or at temperatures outside the specified range may damage the battery and increase the risk of fire.

### **Service**

- Have your power tool serviced by a qualified repair person using only identical replacement parts. This will ensure that the safety of the power tool is maintained.
- Never service damaged battery packs. Service of battery packs should only be performed by the manufacturer or authorized service providers.

### **Precautions**

- The air compressor should only be operated by persons 16 years of age or older. Keep children at a safe distance when using the air compressor.
- The air compressor has a built-in lithium battery and should never be exposed to fire or improperly disposed of. Do not expose the air compressor's battery to high temperature environments, such as leaving it in a car in direct sunlight. If the lithium battery is exposed to extreme heat, impact or water, there is a risk of fire, spontaneous combustion, and even explosion.
- The air compressor should not be stored at temperatures below -10°C or over 45°C. Exposure to extreme heat or cold will shorten the air compressor's service life and damage the built-in battery.
- Leaving the air compressor unused for long periods may harm the battery. It is recommended to charge the air compressor at least once every three months.

- The air compressor uses a built-in DC motor which may produce electrical sparks when running and should never be used in flammable or explosive environments.
- If the air compressor makes an unusual noise while running or starts to overheat, turn it off immediately.
- Always make sure the correct air pressure unit is selected before setting the air pressure to prevent accidents such as a burst tire. Common Unit Conversion: 1 bar = 14.5 psi, 1 bar = 100 kPa.
- Always monitor the air compressor during usage and never leave it unattended when using it without presetting a pressure to avoid over-inflating.
- Only use the air compressor in a clean, dry environment. Intrusion of dirt and dust may cause damage to the air compressor. The air compressor is not waterproof and should never be rinsed with water.

## Product Overview

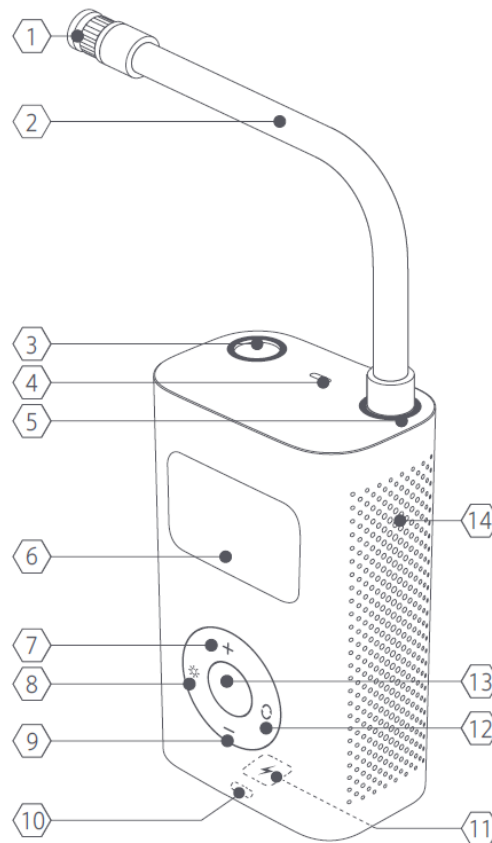

**Note:** Illustrations of the product, its accessories, and its user interface in this user manual are provided for reference only.

## Parts Description

1. Schrader Valve Adapter
2. High-pressure Air Hose
3. Air Hose Compartment
4. Light
5. Air Hose Connection
6. Display
7. + Button
8. Light On/Off Button

9. – Button
10. Battery Level Indicator
11. Charging Port
12. Mode Button
13. Start/Stop Button
14. Heat Dissipation Vent

## Accessories



Presta Valve  
Adapter × 1



Needle Valve  
Adapter × 1



Storage  
Pouch × 1



Charging  
Cable × 1

## Electric Air Compressor Safety Warnings

The battery charger can be used by children aged from 8 years and above and persons with reduced physical, sensory or mental capabilities or lack of experience and knowledge if they have been given supervision or instruction concerning use of the appliance in a safe way and understand the hazards involved. Children shall not play with the appliance. Cleaning and user maintenance shall not be made by children without supervision. Risk of coke formation in the delivery piping causing a fire or explosion.

### Safety Instructions

Please take appropriate precautions to protect your hearing. The air compressor and air hose can get very hot after running for a while. Do not touch hot surfaces until they have cooled down. This product is not a toy and should not be used by children.

### Intended Use

The tool is intended to inflate some motorcycles, bicycles, cars, and balls.

The light of this power tool is intended to illuminate the power tool's direct area of working operation and is not suitable for household room illumination.

The tool is to be used only for its prescribed purpose. Any other use is deemed to be a case of misuse.

## How to Use

## Battery Level Indicator & Charging Battery Level Indicator

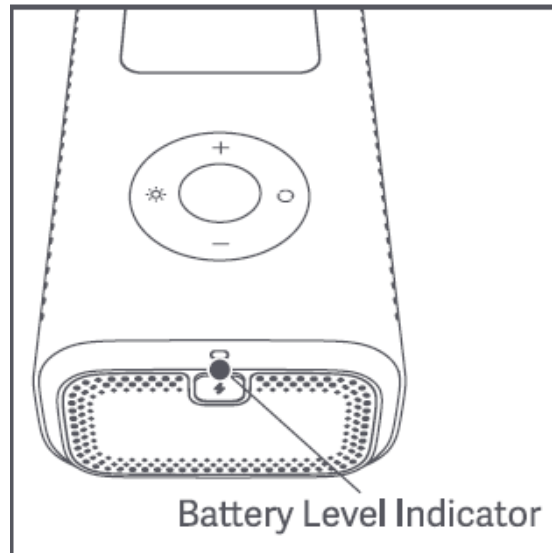

The battery level indicator has different colors to indicate the air compressor's remaining battery level:

- **White:** More than 50%
- **Orange:** 20 to 50%
- **Red:** Less than 20%, charge as soon as possible.

## Charging

Fully charge the air compressor before using it for the first time. Connect the charging cable to a 5 V USB power adapter to charge the air compressor. Battery level indicator while charging: Blinking

- White: Charging
- White: Fully charged

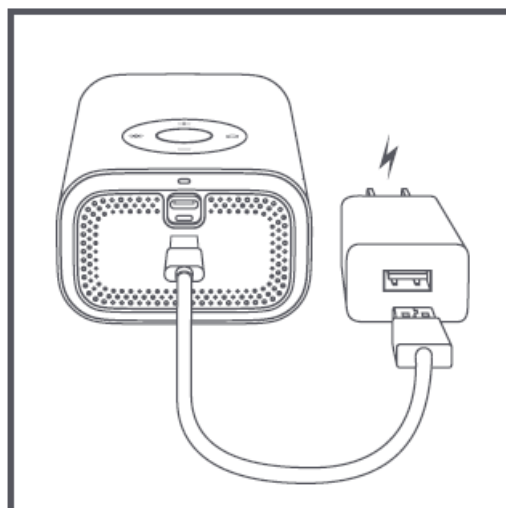

## Note:

- The air compressor cannot be used while charging.
- Please charge indoors.
- Please use the matching charger only.
- A safe and compliant power adapter must be purchased separately.



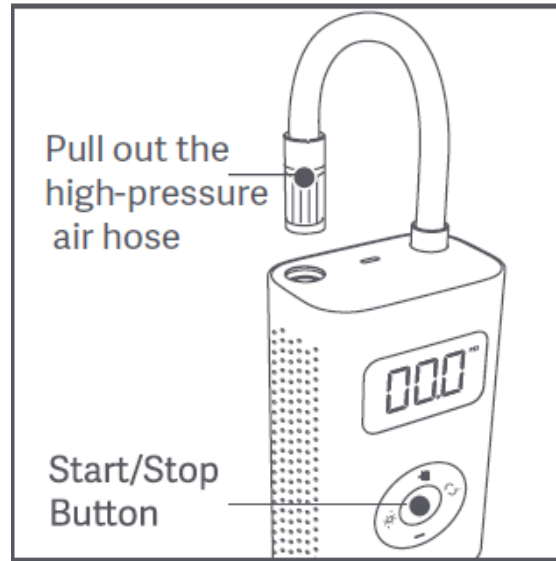

## Turning on / off



**Turning on:** Remove the high-pressure air hose from its compartment, then the air compressor will automatically turn on. If the air compressor is not used for 3 minutes, it will automatically turn off. If the air compressor automatically turns off while the high-pressure air hose is pulled out, press and hold the start/stop button to turn the air compressor on again.

**Turning off:** Insert the high-pressure air hose back into the air compressor to turn it off. To turn it off, press and hold the start/stop button while the air compressor is turned on.

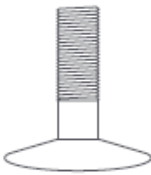
## Connecting the High-pressure Air Hose and Nozzle Schrader Valve



Valve Type	Inflation Adapter
	

Tires on cars, motorcycles, e-bikes, and most mountain bikes use a Schrader valve.

**To inflate:** Connect the Schrader valve adapter on the high-pressure air hose to the Schrader valve to start inflating.

**To deflate:** Use an appropriate tool (for example, a 4 mm hex key) to press the valve stem to release the air. Road bicycles and certain mountain bikes require the included Presta valve adapter to be used.

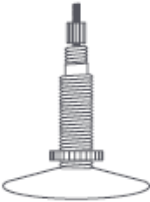
## Presta Valve Adapter



Valve Type	Inflation Adapter
	

**To inflate:**

1. Connect the Presta valve adapter to the Schrader valve adapter on the high-pressure air hose
2. Unscrew the tire's Presta valve.
3. Connect the Presta valve to the adapter to start inflating.

**To deflate:** Unscrew the Presta valve and press the valve stem down to release air.

**Needle Valve Adapter**

Valve Type	Inflation Adapter
	

To inflate balls like basketballs and footballs, the included needle valve adapter will need to be used.

**To inflate:** Screw the needle valve adapter onto the Schrader valve adapter, then insert the needle into the ball's valve to start inflating.

**To deflate:** Insert the needle valve adapter into the valve of the ball, and gently apply pressure to the ball to release air.

**Detecting Air Pressure**

The current air pressure will automatically be displayed after the high-pressure air hose is connected to an item while the air compressor is turned on.

## Determining the Right Air Pressure

To ensure safety and to prevent injuries from explosions due to over-inflation, always refer to the instructions or relevant directions accompanying the item to be inflated before inflating it, in order to determine the correct air pressure.

### Tires

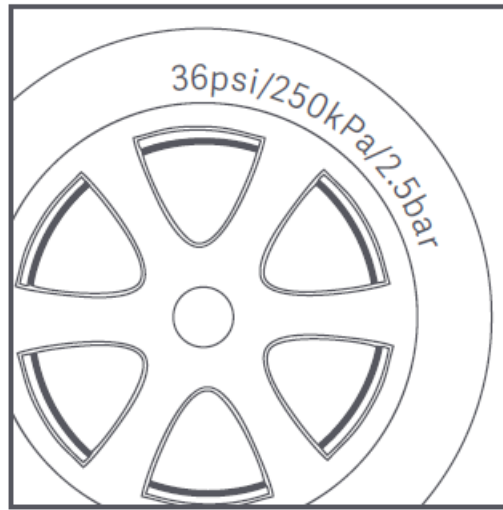

The recommended air pressure of tires for cars, bicycles, and motorcycles is indicated on the tire's sidewall. The recommended tire pressure for cars is also indicated on the driver's side door jamb. For details concerning load carrying capacity and recommended air pressures, refer to your vehicle's instructions or manual.

### Balls

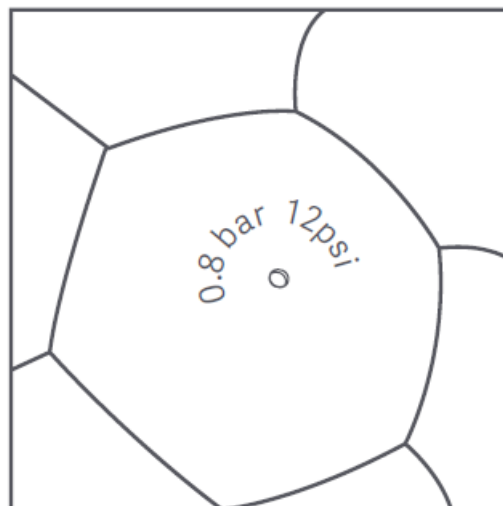

The recommended air pressure for footballs, basketballs, volleyballs, and other balls is indicated near the ball's air valve.

### Air Pressure Reference Table

Category	Type	Recommended Pressure Range
Bicycles	Mi Smart Electric Folding Bike tires	35–45 psi
	12-, 14-, & 16-inch bicycle tires	30–50 psi
	20-, 22-, & 24-inch bicycle tires	40–50 psi
	Mi Electric Scooter tires	40–50 psi
	26-, 27.5-, & 29-inch mountain bike tires	45–65 psi
	700c road bike clincher tires	100–130 psi
	700c road bike tubular tires	120–145 psi
Motorcycle	Motorcycle or electric scooter tires	1.8–3.0 bar
Cars	Car tires	2.2–2.8 bar
Balls	Basketball	7–9 psi
	Soccer ball	8–16 psi
	Volleyball	4–5 psi
	Football	12–14 psi

**Note:** Pressure range values are for reference only. Always refer to the instructions or manual of the item being inflated for actual inflation pressure specifications. (The data above is from the QiCYCLE lab.)

### Pressure Presets

#### Switch Mode

Press the mode button to switch between the five inflation modes below. Select the preferred air pressure unit before inflating by pressing and holding the mode button to toggle between psi and bar.

Manual mode: There's no icon on the left side of the display, and the air pressure can be specified by the user and will be saved.

Adjustable range: 3–150 psi/0.2–10.3 bar.

Bicycle Mode: Default 45 psi Adjustable Range: 30–65 psi



Motorcycle Mode: Default 2.4 bar Adjustable Range: 1.8–3.0 bar



Car Mode: Default 2.5 bar Adjustable Range: 1.8–3.5 bar



Ball Mode: Default 8 psi Adjustable Range: 4–16 psi



### Adjusting the Preset Pressure

After selecting a mode, press + or – to increase or decrease the preset pressure value. Press and hold the + or – button to quickly adjust the pressure value.



When adjusting a preset pressure, the blinking value indicates the target pressure, and a non-blinking value indicates the real-time pressure.



### LIGHT

Press the light on/off button to switch between light on, SOS light, and light off.



### **Inflating**

### **Start Inflating**

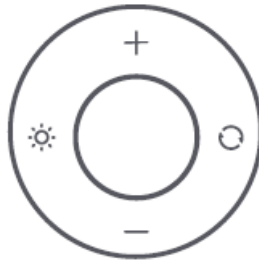

Press the start/stop button to start inflating. The current pressure is displayed in real-time while inflating. When inflating, the air compressor may be as loud as 75–80 dB. Please take appropriate precautions to protect your hearing. The air compressor and air hose can get very hot after running for a while. Avoid prolonged skin contact with the hose to prevent injuries.

### **Stop Inflating**

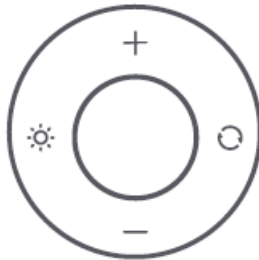

Once the preset pressure value has been reached, the air compressor will automatically stop inflating. The air compressor can also be manually stopped at any time while inflating by pressing the start/stop button once.

### **Caution**

Items such as balloons, beach balls, and swim rings cannot be automatically inflated because they have an air pressure requirement below the air compressor's minimum pressure range. Only inflate these items manually with caution.

### **Battery Information**

The air compressor's battery can last about 40 minutes on a full charge running without a load at an ambient temperature of 25°C. Using the air compressor under a heavy load or at lower ambient temperatures may reduce its battery life.

### **Disconnecting the Air Hose**

The air compressor's air hose may get very hot after inflating. To prevent injuries, exercise caution when disconnecting it from a valve. Some air may leak out of the valve when disconnecting the air compressor. To avoid pressure loss, quickly disconnect the air hose from the valve.

### **Residual risks**

Even when the power tool is used as prescribed it is not possible to eliminate all residual risk factors. The following hazards may arise in connection with the power tool's construction and design:

1. Damage to lungs if an effective dust mask is not worn.
2. Damage to hearing if effective hearing protection is not worn.
3. Damages to health resulting from vibration emission if the power tool is being used over longer period of time or not adequately managed and properly maintained.

**WARNING!** This power tool produces an electromagnetic field during operation. This field may under some circumstances interfere with active or passive medical implants. To reduce the risk of serious or fatal injury, we recommend persons with medical implants to consult their physician and the medical implant manufacturer before operating this machine.

## Care & Maintenance

- Regular cleaning, maintenance, method for keeping tools sharp, and lubrication, charge at least once every three months.
- Do not attempt to repair the product by yourself; only a qualified technician or the professional can repair it. Please contact customer service if needed.
- List of user-replaceable parts (High-pressure Air Hose & Schrader Valve, Presta Valve Adapter, Needle Valve Adapter and Charging Cable) .
- Special tools which may be required, do not disassemble and repair by yourself.

## Battery Safety

- Do not dismantle, open or shred cells. Batteries should be dismantled only by trained personnel. Multi-cell battery cases should be designed so that they can be opened only with the aid of a tool.
- Compartments should be designed to prevent easy access to the batteries by young children.
- Do not short-circuit a cell or battery. Do not store cells or batteries haphazardly in a box or drawer where they may short-circuit each other or be short-circuited by conductive materials.
- Do not remove a cell or battery from its original packaging until required for use.
- Do not expose cells or batteries to heat or fire. Avoid storage in direct sunlight.
- Do not subject cells or batteries to mechanical shock.
- In the event of a cell leaking, do not allow the liquid to come into contact with the skin or eyes. If contact has been made, wash the affected area with copious amounts of water and seek medical advice.
- Equipment should be designed to prohibit the incorrect insertion of cells or batteries and should have clear polarity marks. Always observe the polarity marks on the cell, battery and equipment and ensure correct use.
- Do not mix cells of different manufacture, capacity, size or type within a battery.
- Seek medical advice immediately if a cell or battery has been swallowed.
- Consult the cell or battery manufacturer on the maximum number of cells which may be assembled in a battery and on the safest way in which cells may be connected.
- A dedicated charger should be provided for each equipment. Complete charging instructions should be provided for all secondary cells and batteries offered for sale.
- Keep cells and batteries clean and dry.

- Wipe the cell or battery terminals with a clean dry cloth if they become dirty.
- Secondary cells and batteries need to be charged before use. Always refer to the cell or battery manufacturer's instructions and use the correct charging procedure.
- Do not maintain secondary cells and batteries on charge when not in use.
- After extended periods of storage, it may be necessary to charge and discharge the cells or batteries several times to obtain maximum performance.
- Retain the original cell and battery literature for future reference.
- When disposing of secondary cells or batteries, keep cells or batteries of different electrochemical systems separate from each other.

## **Troubleshooting**



Problem	Solution
Slow inflation speed	<ol style="list-style-type: none"> <li>1. Check whether the air compressor's battery level is sufficient.</li> <li>2. Check whether the air hose is leaking.</li> <li>3. Check whether both ends of the air hose are securely connected.</li> <li>4. Check whether the item that is being inflated is leaking.</li> </ol>
Air compressor turns on but does not inflate	<ol style="list-style-type: none"> <li>1. Check whether the air hose is removed from its compartment before inflating.</li> <li>2. Check whether the air compressor's battery level is sufficient.</li> <li>3. Check whether the pressure of the item that is being inflated exceeds the preset pressure.</li> </ol>
Unable to increase or decrease the preset pressure	Make sure the air compressor is set to the correct mode. It is allowed to adjust the preset value in the range of 3–150 psi in manual mode.
Air compressor inflates normally but the displayed pressure is zero	The pressure of low-pressure inflatables including balloons is too low to measure.
Air compressor already turned off after connecting the air hose to a valve	Press and hold the start/stop button to turn the air compressor on again.
Air leaks out when connecting the air hose	Make sure the air hose is securely connected.
Color of the battery level indicator is different when inflating compared to standby state	The lithium battery's voltage level drops when discharging power, causing the battery level indicator to have a different color when inflating compared to standby state. This is normal.
The indicator does not light up after charging	Replace the adapter with safe and compliant ones, and charge again.

## Specifications

Name	Xiaomi Portable Electric Air Compressor 1S
Model	MJCQB05QJ
Dimensions	124 × 71 × 45.3 mm (Air compressor, excluding air hose)
Inflation Pressure Range	0.2–10.3 bar / 3–150 psi
Operating and Charging Temperature	0 °C to 45 °C
Storage Temperature	-10 °C to 45 °C
Air Hose Dimensions	Air hose length 180 mm (including Schrader valve adapter and excluding thread)
Air Valve Dimensions	Schrader valve adapter: 11 × 20 mm Presta valve adapter: 11 × 15 mm
Battery Capacity	2 Ah (14.8 Wh)
Charging Port	Type-C
Charging Time	Less than 3 hours
Sensor Accuracy	±1 psi
Maximum Allowable Pressure	15 bar
Maximum Motor Speed	16500 rpm
Charging Current	2 A
Net Weight	0.5 kg
Rated Voltage	7.4 V DC
Charging Voltage	5 V DC

## Noise Value and Vibration

### Test result

Noise emission values determined according to EN 62841 – 1 :	
Sound Pressure Level	L <sub>pA</sub> = 71 dB (A)
Uncertainty	K= 3 dB
A-weighted Sound Power Level	L <sub>wA</sub> = 82 dB (A)
Uncertainty	K= 3 dB
Declared A-weighted Sound Power Level (according to EN 1012-1)	85 dB (A)
Vibration total values determined according to EN 62841-1:	
Vibration Emission Value	a <sub>h</sub> = 3.1 m/s <sup>2</sup>
Uncertainty	K = 1.5 m/s <sup>2</sup>

### **Wear hearing protection while operating the power tool.**

The declared vibration total value(s) and the declared noise emission value(s) have been measured in accordance with a standard test method and may be used for comparing one tool with another.

The declared vibration total value(s) and the declared noise emission value(s) may also be used in a preliminary assessment of exposure.

### **Warning:**

The vibration emission and noise emissions during actual use of the power tool can differ from the declared total value depending on the ways in which the tool is used.

There is the need to identify safety measures to protect the operator that are based on an estimation of exposure in the actual conditions of use (taking account of all parts of the operating cycle such as the times when the tool is switched off and when it is running idle in addition to the trigger time).

### **Symbol Descriptions**

- Please see the bottom of the air compressor for the EAC logo.
- Read the user manual before using.
- Wear hearing protection while operating the tool.
- Wear the eyes protection when use the tool.
- Batteries and rechargeable batteries are not household waste! As a consumer, you are required by law to dispose of all batteries and accumulators, whether or not they contain harmful substances \*, at a collection point in your municipality / neighborhood or in commerce so that they can be disposed of in an environmentally sound manner. \* marked with: Cd = cadmium, Hg = mercury, Pb = lead.
- For indoor use only.
- Safety alert.
- Risk of high temperature.
- All products bearing this symbol are waste electrical and electronic equipment (WEEE as in directive 2012/19/EU) which should not be mixed with unsorted household waste. Instead, you should protect human health and the environment by handing over your waste equipment to a designated collection point for the recycling of waste electrical and electronic equipment, appointed by the government or local authorities. Correct disposal and recycling will help prevent potential negative consequences to the environment and human health. Please contact the installer or local authorities for more information about the location as well as

terms and conditions of such collection points.

## **To Recycling Organizations**

### **Remove the battery**

1. Operate the power tool until the battery is completely discharged(empty).
2. Unscrew the screws on the enclosure and remove the enclosure.
3. Disconnect the connectors on the battery one at a time to prevent a short circuit.
4. Remove the battery.
5. Isolate the poles. Even with complete discharge battery still has a residual capacity in the battery included, which can be released in the event of a short circuit.

Please see the back of the air compressor for the production date.

We, iRiding (Xiamen) Technology Co., Ltd., hereby, declare that this equipment is in compliance with the applicable Directives and European Norms, and amendments. The full text of the EU declaration of conformity is available at the following internet address: <http://www.mi.com/global/service/support/declaration.html>

EU Representative: Prolinx GmbH

Address: Brehmstr. 56, 40239 Duesseldorf, Germany

WeiRiding (Xiamen) Technology Co., Ltd., hereby, declares that this equipment is in compliance with the applicable Legislation. The full text of the UK declaration of conformity is available at the following internet address: <https://www.mi.com/uk/service/support/declaration.html>

UKCA Representative:Prolinx Global LTD

Address: 27 Old Gloucester Street,London, WC1N 3AX, UK

Manufactured for: Xiaomi Communications Co., Ltd.

Manufactured by: iRiding (Xiamen) Technology Co., Ltd.

(a Mi Ecosystem company)

Address: Room 403, NO.768 Qishan North Road, Huli District, Xiamen , Fujian Province, P.R. CHINA

For further information, please go to [www.mi.com](http://www.mi.com)

## **FAQS**

### **What is the Xiaomi Portable Electric Air Compressor 1S used for?**

The Xiaomi Portable Electric Air Compressor 1S can be used for a variety of purposes, such as inflating car tires, sports equipment, and inflatable toys.

### **Is it important to read the user manual before using the air compressor?**

Yes, it is important to read the user manual carefully before using the air compressor and to retain it for future reference.



### **What are some safety precautions that should be followed when using the air compressor?**

Some safety precautions that should be followed include keeping the work area clean and well-lit, avoiding operating the air compressor in explosive atmospheres, wearing personal protective equipment, and using the correct power tool for your application.

### **Can the air compressor be used by children?**

No, the air compressor should only be operated by persons 16 years of age.

## Documents / Resources

	<p><a href="#">Xiaomi Portable Electric Air Compressor 1S</a> [pdf] User Manual Portable Electric Air Compressor 1S</p>
	<p><a href="#">Xiaomi Portable Electric Air Compressor 1S</a> [pdf] User Manual Portable Electric Air Compressor 1S, Electric Air Compressor 1S, Air Compressor 1S, Compressor 1S</p>

## References

- [Mi United States](#)
- [UK DECLARATION OF CONFORMITY](#)